

# GP1 User Guide

---

PROGRAMMABLE ACCELEROMETER



Version 2.2  
August 27, 2007



## TABLE OF CONTENTS

	<b>QUICK START GUIDE</b>	5
	<b>BEFORE YOU BEGIN</b>	6
	1.1 Packing List	6
	<b>GETTING STARTED</b>	6
	2.1 Installing Batteries	6
	2.2 Installing the Software	6
	2.3 Connecting the Hardware	7
	2.4 Launching the Software	9
	2.5 Review the User Manual	9
	2.6 Technical Support	9
	<b>GP1 USER GUIDE</b>	10
<b>1</b>	<b>PREAMBLE</b>	11
	1.1 FCC Statement	11
	1.2 Software License Agreement	11
	1.3 Acceptable Use	12
	1.4 Safe Transport	13
<b>2</b>	<b>GP1 PROGRAMMABLE ACCELEROMETER</b>	13
	2.1 General	13
	2.2 Specifications	13
	2.3 Acceleration Ranges	13
	2.4 Data Recorder Mode	14
	2.5 Event Recorder Mode	14
	2.6 Real-Time Data Capture Mode	14
	2.7 LED Status Indicator	15
	2.8 Start Button	15
<b>3</b>	<b>DATA RECORDER MEASUREMENTS AND FEATURES</b>	15
	3.1 Maximum Axis Acceleration	15
	3.2 Minimum Axis Acceleration	15
	3.3 Average Axis Acceleration	15
	3.4 Axis Threshold Counter	16



## TABLE OF CONTENTS continued

3.5	Vector Magnitude (VM) Max	16
3.6	Vector Magnitude (VM) Average	16
3.7	Vector Magnitude Threshold Counter	16
3.8	Orientation	16
3.9	Near Zero G	16
3.10	Peak Duration	16
3.11	Temperature	17
3.12	Button Press	17
3.13	Alerts	17
<b>4</b>	<b>EVENT RECORDER MEASUREMENTS</b>	<b>18</b>
4.1	Axis Acceleration	18
4.2	Temperature	18
<b>5</b>	<b>SYSTEM SETUP</b>	<b>19</b>
5.1	Battery Information	19
5.2	Installing Batteries	19
5.3	Installing the Software	19
5.4	Connecting the GP1	20
<b>6</b>	<b>SENSWARE</b>	<b>21</b>
6.1	Sensware Description	21
6.2	Accessing Help	21
6.3	Using Sensware	21
6.4	Connecting to a GP1	22
6.5	Main Control Panel	23
6.6	Device Initialization	23
6.7	GP1 Init General	24
6.8	GP1 Init Data Recorder	25
6.9	GP1 Init Event Recorder	26
6.10	Downloading Data	27
6.11	Reviewing the Data	27
6.12	Device Information	30
6.13	Real Time Data Capture	31



## TABLE OF CONTENTS continued

<b>7</b>	<b>CONFIGURING THE DATA RECORDER</b>	<b>33</b>
7.1	XYZ Axis	33
7.1.1	XYZ Axis Measurements	33
7.1.2	XYZ Axis Settings	34
7.1.3	XYZ Axis Alerts	35
7.2	Vector Magnitude	36
7.2.1	Vector Magnitude Measurements	36
7.2.2	Vector Magnitude Settings	37
7.2.3	Vector Magnitude Alerts	38
7.3	Orientation	39
7.3.1	Orientation Settings	39
7.3.2	Orientation Alerts	40
7.4	Near Zero G	41
7.4.1	Near Zero G Measurements	41
7.4.2	Near Zero G Settings	42
7.4.3	Near Zero G Alerts	43
7.5	Peak Duration	44
7.5.1	Peak Duration Settings	44
7.5.2	Peak Duration Alerts	46
7.6	Temperature	47
7.6.1	Temperature Alerts	47
7.7	Button Press	48
<b>8</b>	<b>CONFIGURING THE EVENT RECORDER</b>	<b>49</b>
<b>9</b>	<b>SAVING DATA</b>	<b>50</b>
<b>10</b>	<b>EXPORTING DATA</b>	<b>50</b>
<b>11</b>	<b>MISCELLANEOUS</b>	<b>50</b>
11.1	GP1 Maintenance	50
11.2	Technical Support	50
11.3	Product Warranty	50



# GP1 Quick Start Guide

---



## 1 BEFORE YOU BEGIN

---

### 1.1 Packing List

Please confirm that you received a complete GP1 Programmable Accelerometer kit.

You should have received:

- 1 x GP1 Programmable Accelerometer
- 1 x USB Interface cable
- 2 x AA Batteries
- 1 x Sensware CD

## 2 GETTING STARTED

---

### 2.1 Installing Batteries

The GP1 Programmable Accelerometer is powered by two AA alkaline batteries. To install the batteries you must remove the access cover (See Figure 1). The cover is secured to the housing by 2 quarter-turn fasteners. Remove the cover by turning the fasteners counter-clockwise approximately  $\frac{1}{4}$  of a turn.

Once the fastener disengages, it will pop up and you can lift the cover off of the housing. The SENSR GP1's battery box contains an embossed diagram that illustrates proper battery orientation; please consult this diagram before installing the batteries.

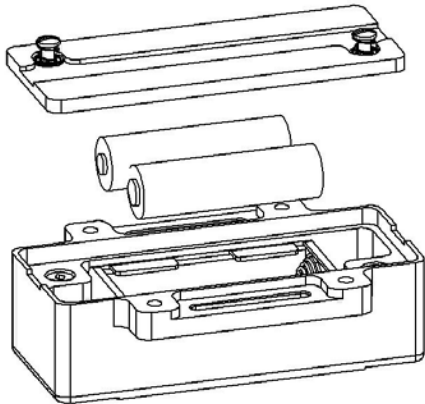

Figure 1 Battery Access Cover

### 2.2 Installing the Software

Before installing the software take a moment and verify that the computer meets the following minimum systems requirements:

- Operating System: Windows 2000 SP4 or Windows XP SP2
- CPU: Pentium 4, 2.00GHz
- System Memory (RAM): 512MB
- Hard Disk: 200MB free space
- Display: 1024 x 768, 32-bit "True Color"



The software for the GP1 Programmable Accelerometer is based upon Microsoft's .NET Framework. You can download this environment from Microsoft using your Windows update utility.

Depending on your update settings you may need to select the Custom update option. The .NET Framework 2.0 is considered an optional component and is listed in the Software category.

**You must install the .NET Framework 2.0 before you install the Sensware application.**

To install the Sensware application:

- Insert the CD into your CD/ DVD drive.
- Double-click your My Computer icon.
- Double-click your CD / DVD drive icon.
- Double-click the Sensware set -up icon (See Figure 2).
- Follow the installation wizard's instructions.



Figure 2 Set-up icon

## 2.3 Connecting the Hardware

The Sensr GP1 Programmable Accelerometer communicates with your computer via USB. Connect the supplied USB cable to your computer. The GP1 features an internal USB connector; you must remove the access cover (See Figure 1) in order to connect the GP1. The cover is secured to the housing by 2 quarter-turn fasteners. Remove the cover by turning the fasteners counter-clockwise approximately  $\frac{1}{4}$  of a turn, once the fastener disengages it will pop up and you can lift the cover off of the housing.

The GP1 has a mini-B USB connector that is located in a pocket between the battery box and the housing (See Figure 3). Note that it is a keyed connector and you are required to align the USB cable before plugging it in.

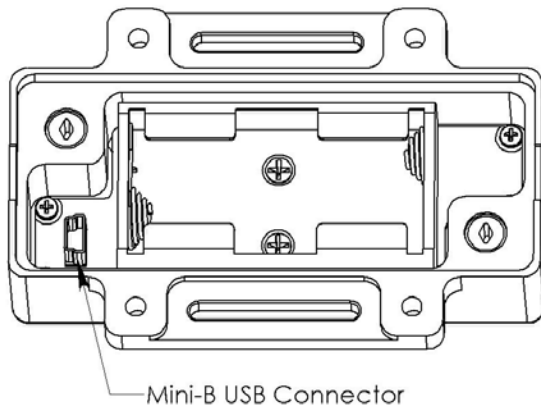

Figure 3. Mini-B Connector



To install the GP1 hardware, first plug the USB cable into the USB connector on the GP1 and into an available USB connector on the computer.



You should see an indication near the system tray that the computer has detected new hardware.



A moment later, a dialog will appear for the Found New Hardware Wizard. Do not allow the wizard to connect to Windows Update to search for software. Click the Next button.

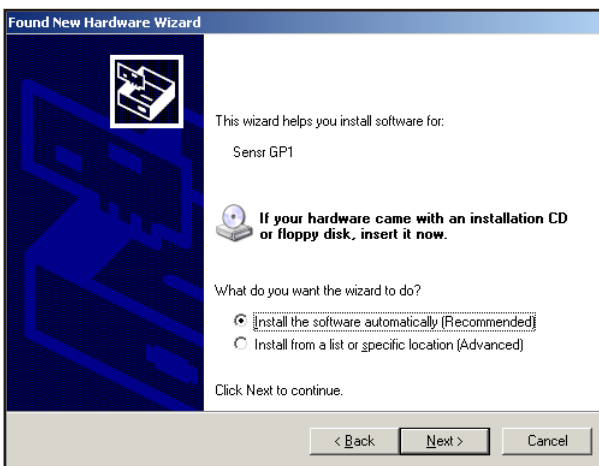

Allow the wizard to install the software automatically. If the wizard cannot find the correct software, you can install from a specific location, which is the root of the CD-ROM. Click the Next button.



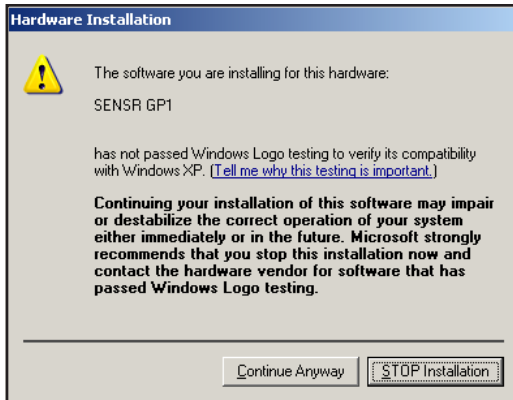

A warning will appear to advise you that the software has not passed Windows Logo testing. This is not a problem. Click the Continue Anyway button.

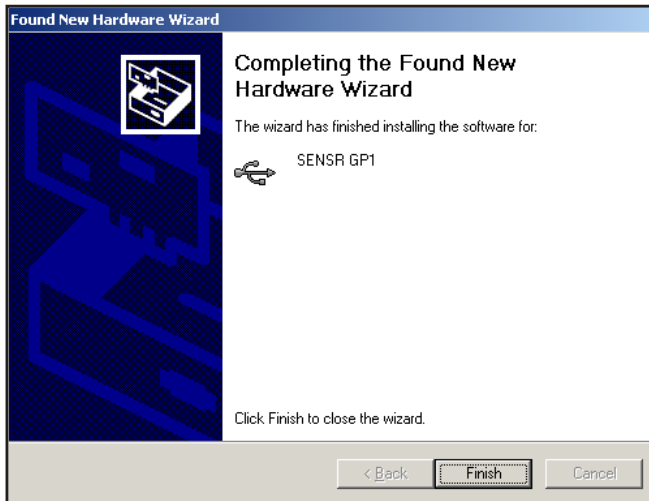

When the wizard is finished, this dialog appears. Click the Finish button.

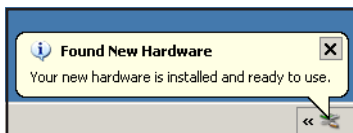

You should see an indication near the system tray that the computer has finished installing the hardware.

## 2.4 Launching the Software

To launch Sensware select Start>Programs>Sensware

## 2.5 Review the User Manual

We recommend that you review the User's Manual; the manual can be found under the Help menu.

## 2.6 Technical Support

If you have any questions about the product or require technical support please email us at support@sensr.com or call 563.245.3750.



# GP1 User Guide

---



## 1 PREAMBLE

---

### 1.1 FCC Statement

This device complies with Part 15 of the FCC rules. Operation is subject to the following two conditions:

- This device may not cause harmful interference.
- This device must accept any interference received, including interference that may cause undesirable operation.

### 1.2 Software License Agreement

PLEASE READ THIS SOFTWARE LICENSE AGREEMENT CAREFULLY BEFORE USING THE SOFTWARE.

**License Grant:** Reference LLC. ("Reference") and its suppliers grant to Customer ("Customer") a nonexclusive and nontransferable license to use the Sensware software ("Software") in object code form only on as many central processing units as is required to support the functionality of the products used in conjunction with this software.

EXCEPT AS EXPRESSLY AUTHORIZED ABOVE, CUSTOMER SHALL NOT: COPY, IN WHOLE OR IN PART, SOFTWARE OR DOCUMENTATION; MODIFY THE SOFTWARE; REVERSE COMPILE OR REVERSE ASSEMBLE ALL OR ANY PORTION OF THE SOFTWARE; OR RENT, LEASE, DISTRIBUTE, SELL, OR CREATE DERIVATIVE WORKS OF THE SOFTWARE.

Customer agrees that aspects of the licensed materials, including the specific design and structure of individual programs, constitute trade secrets and/or copyrighted material of Reference. Customer agrees not to disclose, provide, or otherwise make available such trade secrets or copyrighted material in any form to any third party without the prior written consent of Reference. Customer agrees to implement reasonable security measures to protect such trade secrets and copyrighted material. Title to Software and documentation shall remain solely with Reference.

**SOFTWARE WARRANTY.** Reference warrants that for a period of ninety (90) days from the date of shipment from Reference: (i) the media on which the Software is furnished will be free of defects in materials and workmanship under normal use; and (ii) the Software substantially conforms to its published specifications. Except for the foregoing, the Software is provided AS IS. This limited warranty extends only to Customer as the original licensee. Customer's exclusive remedy and the entire liability of Reference under this limited warranty will be, at Reference's option, repair, replacement, or refund of the Software. In no event does Reference warrant that the Software is error free or that Customer will be able to operate the Software without problems or interruptions. This warranty does not apply if the software (a) has been altered, except by Reference, (b) has not been installed, operated, repaired, or maintained in accordance with instructions supplied by Reference.

**DISCLAIMER.** EXCEPT AS SPECIFIED IN THIS WARRANTY, ALL EXPRESS OR IMPLIED CONDITIONS, REPRESENTATIONS, AND WARRANTIES INCLUDING, WITHOUT LIMITATION, ANY IMPLIED WARRANTY OF MERCHANTABILITY, FITNESS FOR A PARTICULAR PURPOSE,



NON-INFRINGEMENT OR ARISING FROM A COURSE OF DEALING, USAGE, OR TRADE PRACTICE, ARE HEREBY EXCLUDED TO THE EXTENT ALLOWED BY APPLICABLE LAW. IN NO EVENT WILL REFERENCE BE LIABLE FOR ANY LOST REVENUE, PROFIT, OR DATA, OR FOR SPECIAL, INDIRECT, CONSEQUENTIAL, INCIDENTAL, OR PUNITIVE DAMAGES HOWEVER CAUSED AND REGARDLESS OF THE THEORY OF LIABILITY ARISING OUT OF THE USE OF OR INABILITY TO USE THE SOFTWARE EVEN IF REFERENCE HAS BEEN ADVISED OF THE POSSIBILITY OF SUCH DAMAGES. In no event shall Reference's liability to Customer, whether in contract, tort (including negligence), or otherwise, exceed the price paid by Customer. The foregoing limitations shall apply even if the above-stated warranty fails of its essential purpose. SOME STATES DO NOT ALLOW LIMITATION OR EXCLUSION OF LIABILITY FOR CONSEQUENTIAL OR INCIDENTAL DAMAGES.

The above warranty DOES NOT apply to any beta software, any software made available for testing or demonstration purposes, any temporary software modules or any software for which Reference does not receive a license fee. All such software products are provided AS IS without any warranty whatsoever. This License is effective until terminated. Customer may terminate this License at any time by destroying all copies of Software including any documentation. This License will terminate immediately without notice from Reference if Customer fails to comply with any provision of this License. Upon termination, Customer must destroy all copies of Software.

Software, including technical data, is subject to U.S. export control laws, including the U.S. Export Administration Act and its associated regulations, and may be subject to export or import regulations in other countries. Customer agrees to comply strictly with all such regulations and acknowledges that it has the responsibility to obtain licenses to export, re-export, or import Software.

This License shall be governed by and construed in accordance with the laws of the State of Iowa, United States of America, as if performed wholly within the state and without giving effect to the principles of conflict of law. If any portion hereof is found to be void or unenforceable, the remaining provisions of this License shall remain in full force and effect. This License constitutes the entire License between the parties with respect to the use of the Software.

### 1.3 Acceptable Use

The Sensr GP1 is a general-purpose instrument only, it is not recommended for any use that requires critical measurement or precision triggering. The GP1 is not to be used for:

- i) Critical testing
- ii) Monitoring life support or patient diagnoses
- iii) Any type of input or controller for any process or system including but not limited to:
  - a) Automated production or manufacturing
  - b) Life support or patient diagnosis
  - c) Vehicle or machine control
  - d) Emergency, redundant or backup systems

The GP1 is designed to be used in a protected environment and should not be exposed to liquids.

It is the responsibility of the user to confirm that any use of the product conforms with all country, federal, state, county, municipal laws, ordinances and regulations, if any, applicable to the transport and use of the GP1.



## 1.4 Safe Transport

As the manufacturer of the GP1, Reference, LLC, has contacted the United States Department of Transportation in an effort to seek guidance and usage instructions for the GP1 for the user. Reference, LLC, recommends the power source for the GP1 to be 2 x AA alkaline batteries. The Department of Transportation has stated that there are no restrictions related to the use of the GP1 following the recommending power source. The Department of Transportation has cited the following notice for consideration when using an alternative power source for the unit.

DEPARTMENT OF TRANSPORTATION  
Research and Special Programs Administration  
[Docket No. RSPA-99-5143; Notice No. 99-8]  
Advisory Guidance; Transportation of Batteries and Devices That Contain Batteries  
AGENCY: Research and Special Programs Administration (RSPA), DOT.  
ACTION: Advisory guidance.

## 2 GP1 PROGRAMMABLE ACCELEROMETER

### 2.1 General

The GP1 Programmable Accelerometer is a 3-axis motion recording instrument that allows the user to monitor, record and evaluate: motions, impacts, shocks, drops, orientation and temperature.

### 2.2 Specifications

Size:	3.935" x 2.560" x 1.140"
Weight With Batteries:	8.25 oz
Housing Material:	6061 - T6 Aluminum
Power:	2 x AA Alkaline Batteries
Battery Life:	More than 40 Days
Connectivity:	USB
Accelerometer Type:	Programmable 3 Axis MEMS
Accelerometer Range:	User programmable $\pm 2.5g$ , $\pm 3.3g$ , $\pm 6.7g$ , $\pm 10g$
Frequency Response:	DC - 45Hz
Sampling Rate:	100Hz per axis
Memory Type:	Non-Volatile EEPROM
Memory Size:	1 Megabyte
Device Temperature Range:	-20°C to +80°C

### 2.3 Acceleration Ranges

The GP1 incorporates a programmable 3-axis MEMS accelerometer. The user can select which range is appropriate for their application. The four acceleration ranges are:  $\pm 2.5g$ ,  $\pm 3.3g$ ,  $\pm 6.7g$  and  $\pm 10g$ . It is recommended that the user select the lowest range reasonable for their application as this will optimize data. Choosing an acceleration range does not limit the survivability of the accelerometer; the accelerometer is shock rated for more than 1000gs.



## 2.4 Data Recorder Mode

When the GP1 collects data in the Data Recorder Mode it organizes sampled data into user-specified reporting intervals. A reporting interval is defined by a time segment the user defines; a time segment can be between 1 second and 120 seconds. The reporting interval does not influence the way the GP1 collects data, it only specifies the time resolution for reporting the data. For example, if the GP1 is set to report X+ axis max values with the specification of a 1 second reporting interval, the unit will sample at 100 samples per second and report the single highest sample within a given 1 second period. If the device's reporting interval were reset to 60 seconds the GP1 would still sample at 100 samples per second but report the highest sample that occurred within the 60 second period. Choosing a shorter reporting interval will result in more data records for a given monitoring period. Selecting an appropriate reporting interval is a balance between data resolution, record length and storage capacity. Once a reporting interval is specified the software will display the number of days and hours the unit will store data. In general 60 second epochs is a good reporting interval for most applications—it facilitates reasonable data resolution and an extended monitoring period.

**Note: The GP1 reports all records in UTC time.**

## 2.5 Event Recorder Mode

The GP1 can also be programmed to collect data in the Event Recorder Mode. This mode records each sample (3 axis—100 samples per second) into sequenced data records. Once the Event Recorder Mode is enabled the user can specify when the mode triggers and how long the mode records data. This mode can be used in conjunction with Data Recorder Mode.

## 2.6 Real-Time Data Capture Mode

The GP1 can be configured to be a real-time data capture device—this mode lets the user see the real-time acceleration influences as they are occurring. For this function the unit needs to be connected to the user's PC via the USB cable. No other modes can be used while Real-Time mode is enabled. Once enabled, the user can control when the system records/displays data. Recording control can be done on the PC or at the instrument. USB extenders can be used with this mode to increase the cable length if required.



## 2.7 LED Status Indicator

The GP1 has an LED indicator that can be used to quickly determine the status of the unit. Depending upon the unit's status, the LED will flash green, yellow or red. Each flash color and flash frequency has a specific meaning depending upon which mode is enabled:

### Data Recording Mode

Single green flash every 2 seconds	Recording normally with no alerts
½ Second green illumination	Button press input has been stored
Yellow triple-flash every 2 seconds	GP1 is armed and awaiting a trigger to start recording
Yellow single-flash every 2 seconds	Recording data; low battery
Red single-flash every 2 seconds	Recording with an alert condition detected
Red triple-flash	Not recording with alerts

### Event Recorder Mode

Rapid yellow	Not recording data
Rapid green	Recording data

### Stream Mode

Solid red	Not Sampling Data
Solid green	Sampling Data

## 2.8 Start Button

The GP1 features a top mounted "Start" button. This button is used to control data recording as well as inserting notice inputs into the data record.

## 3 DATA RECORDER MEASUREMENTS AND FEATURES

### 3.1 Maximum Axis Acceleration

The GP1 monitors each axis at the fixed rate of 100 samples per second. Peak accelerations are reported for each user specified reporting interval. A peak acceleration value is the highest single sample. Acceleration inputs are filtered through an analog 2 pole Butterworth low pass filter that has a cut-off frequency of 45Hz.

### 3.2 Minimum Axis Acceleration

Minimum axis acceleration values are the lowest acceleration values sampled. If no negative acceleration values were sampled then the minimum value will be greater than or equal to zero. If a negative axis acceleration input was sampled then the value would be the greatest negative acceleration value sampled.

### 3.3 Average Axis Acceleration

The average axis acceleration is the sum of the inputs (100 samples per second) divided by the user-specified reporting interval. The GP1 can be configured to absolute value the inputs before reporting the average.



### 3.4 Axis Threshold Counter

The axis threshold counter counts the number of times the acceleration value for the axis exceeds a user-specified threshold.

### 3.5 Vector Magnitude (VM) Max

Vector magnitude is a single acceleration value that quantifies 3-axis acceleration. The equation for vector magnitude is:

$$r = \sqrt{x^2 + y^2 + z^2}.$$

Vector magnitude max is calculated each sample period (100 samples per second) and is the single highest combined axis instance per reporting interval.

### 3.6 Vector Magnitude (VM) Average

Vector magnitude average is the sum of the VM calculations for the reporting interval divided by the number of samples taken during the reporting interval.

### 3.7 Vector Magnitude Threshold Counter

The VM threshold counter counts the number of times the vector magnitude exceeds the user-specified threshold.

### 3.8 Orientation

Orientation is defined as which face is up—the accelerometer is looking for gravity and the largest continuous gravity component to determine which face is up. The GP1 records a complete orientation record citing the time, orientation(s) and duration.

### 3.9 Near Zero G

Near zero g is a definable threshold that is used to indicate a freefall condition. A freefall condition is achieved when the unit is not being supported and is under the influence of gravity. Examples of freefall conditions include tosses, drops and throws. The GP1 monitors how many times it senses a freefall condition as well as the duration of the event.

### 3.10 Peak Duration

Peak duration is a measurement that captures additional details about an acceleration input. Peak duration monitors VM inputs and reports:

- a) Peak VM Acceleration
- b) Duration of the acceleration event that was over a specified threshold
- c) Velocity change associated with the event





### 3.11 Temperature

The unit has an internal temperature sensor that is used for accelerometer temperature compensation. The sensor is placed adjacent to the accelerometer and measures the internal temperature of the GP1. The temperature sensor is factory calibrated to be within  $\pm 1.5^\circ\text{C}$ . Since the GP1 is an extremely low-power device and does not generate any appreciable heat, it does not affect the reported temperature. The GP1 samples temperature every 10 seconds.

The GP1's temperature response rating is:

#### Moving Air

- Time to reach 50% of temperature difference  
5 minutes 10 seconds
- Time to reach 90% of temperature difference  
19 minutes

#### Still Air

- Time to reach 50% of temperature difference  
11 minutes 15 seconds
- Time to reach 90% of temperature difference  
1 hour 8 minutes

### 3.12 Button Press

The GP1 records when the start button is pressed and held for  $\frac{1}{2}$  second. The event is recorded in the data record and can be used to indicate significant events or timeframes.

### 3.13 Alerts

Alerts are individual alarm conditions that the user specifies. Once an alert value is registered the GP1 will indicate that an alert has been stored by triggering the GP1's LED to begin flashing red. Alerts are indicated and reported in the data record and the summary reports.

Alerts can be specified for the following parameters:

<b>Axis Maximum</b>	Alert will be triggered when a single sampled acceleration value achieves or exceeds the specified value.
<b>Axis Minimum</b>	Alert will be triggered when a single sampled acceleration value achieves or exceeds the specified values. Axis minimum alerts can be used for negative axis acceleration alerts.
<b>Axis Average</b>	Alert will be triggered when the average acceleration value for the reporting interval achieves or exceeds the specified value.
<b>Axis Threshold Count</b>	Alert will be triggered when the number of threshold counts for the reporting interval achieves or exceeds the user-specified value.
<b>VM Max</b>	Alert will be triggered when a single sampled acceleration value achieves or exceeds the specified value.
<b>VM Average</b>	Alert will be triggered when the average acceleration value for the reporting interval achieves or exceeds the specified value.
<b>VM Threshold Count</b>	Alert will be triggered when the number of threshold counts for the reporting interval achieves or exceeds the user-specified value.



<b>Orientation</b>	Orientation alerts require that the user specify a preferred orientation. The preferred orientation will indicate how the user will mount the GP1 to the object of interest. Once this orientation is specified the unit will trigger an alert whenever the attitude changes.
<b>Peak Duration</b>	Peak Duration alerts can be set up to trigger on any one or all of the settable parameters: peak acceleration input, input duration and velocity change.
<b>Temperature High</b>	Alert will trigger when the unit records a temperature equal to or higher than the specified temperature.
<b>Temperature Low</b>	Alert will trigger when the unit records a temperature equal to or lower than the specified temperature.
<b>Button Press</b>	Once the GP1 has been initialized the user can embed a special time-stamp entry into the data record by pressing and holding the "Start" button for ½ second. The unit's status LED will flash green when an entry has been stored.

## 4 EVENT RECORDER MEASUREMENTS

---

### 4.1 Axis Acceleration

Event Recorder Mode records each of the individual axis samples (100 samples / second) for display and analysis. The user can configure when the instrument records data by specifying a trigger condition. Acceleration inputs are filtered through an analog 2 pole Butterworth low pass filter that has a cut-off frequency of 45Hz.

### 4.2 Temperature

Event Recorder Mode samples and reports the instrument temperature; see section 3.9 for system characteristics.



## 5 SYSTEM SETUP

### 5.1 Battery Information

The GP1 is powered by 2 x AA 1.5V batteries. It is recommended that you use high quality alkaline batteries—doing so will ensure a usable battery life of more than 40 days. All batteries have a recommended operating temperature range. The user needs to consult the specifications for the battery intended to be used and verify that its temperature range is adequate for the intended applications. Other battery types are available if extended temperature ranges are needed. The GP1's operating temperature range is -20°C to +80°C. If the GP1 is to be stored for more than 20 days remove the batteries and store them separately.

### 5.2 Installing Batteries

To install the batteries the access cover must be removed (See Figure 1). The cover is secured to the housing by 2 quarter-turn fasteners. Remove the cover by turning the fasteners counter-clockwise approximately ¼ of a turn. Once the fastener disengages it will pop up, enabling the cover to be lifted off the housing. The GP1's battery box contains an embossed diagram that illustrates proper battery orientation; please consult this diagram before installing the batteries.

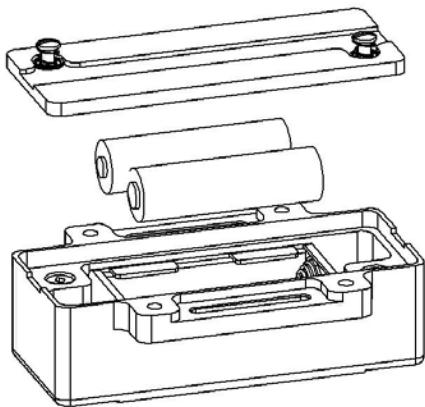

Figure 1 Battery Access Cover

### 5.3 Installing the Software

Before installing the software verify that the computer meets the following minimum systems requirements:

- Operating System: Windows 2000 SP4 or Windows XP SP2
- CPU: Pentium 4, 2.00 GHz
- System Memory (RAM): 512 MB
- Hard Disk: 200 MB free space
- Display: 1024 x 768, 32-bit "True Color"

The software for the GP1 Programmable Accelerometer is based upon Microsoft's .NET Framework. You can download this environment from Microsoft using the Windows update utility. Depending on the update settings the "Custom" update option may need to be selected. The .NET Framework 2.0 is considered an optional component and is listed in the Software category.

**You must install the .NET Framework 2.0 before you install the Sensware application.**



To install the Sensware application:

- a) Insert the CD into your CD/ DVD drive.
- b) Double-click your My Computer icon.
- c) Double-click your CD / DVD drive icon.
- d) Double-click the Sensware set -up icon (See Figure 2).
- e) Follow the installation wizard's instructions.



Figure 2 Set-up icon

## 5.4 Connecting the GP1

The Sensr GP1 Programmable Accelerometer communicates with the computer via USB. Connect the supplied USB cable to the computer. The GP1 features an internal USB connector; the access cover must be removed (See Figure 1) in order to connect the GP1. To remove the access cover please see section 5.2.

The GP1 has a mini-B USB connector that is located in a pocket between the battery box and the housing (See Figure 3). Note that it is a keyed connector and must be aligned the USB cable before being plugged in.

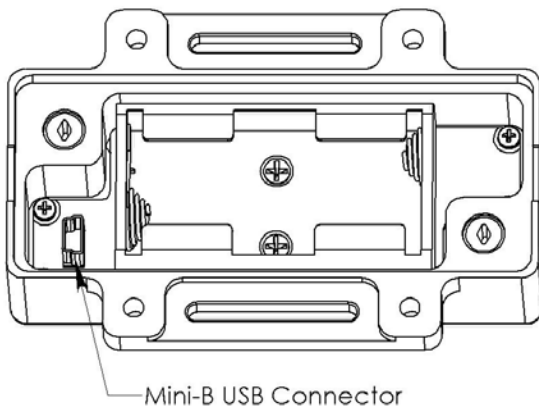

Figure 3 Mini-B Connector



## 6 SENSWARE

### 6.1 Sensware Description

Sensware is the software interface that controls Sensr instruments. Sensware is an intuitive program that enables you to configure the instrument, download mission data, sort /analyze the collected data, generate reports and export data files.

### 6.2 Accessing Help

The Sensware program incorporates context sensitive help. To access this assistance the user can

- left-click the question mark icon in the upper right corner of the window and then left-click the entry field or
- select the entry field and press the F1 key on the keyboard.

### 6.3 Using Sensware

To launch Sensware: select Programs>Sensware>Sensware. The Sensware launch screen will appear (see Figure 4).

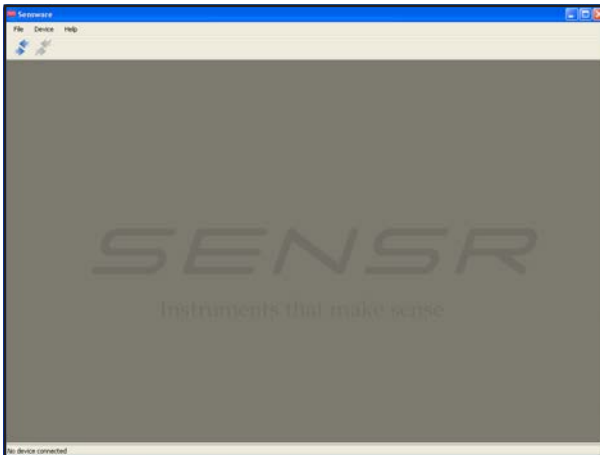

Figure 4 Sensware launch screen

From the Sensware launch screen (Figure 4) the user can:

- |                  |                                      |
|------------------|--------------------------------------|
| File > Open      | Open an .snr file                    |
| File > Exit      | Close Sensware                       |
| Device > Connect | Connect to a Sensr instrument        |
| Help > Manual    | Open the GP1 User's Manual           |
| Help > About     | Display Sensware program information |



## 6.4 Connecting to a GP1



Figure 5 Connect Icon

Click the “Connect” icon (Figure 5) to connect to a GP1—the GP1 must be connected to the PC before the user attempts to connect. Once the software completes the scan for connected instruments a Device Connect screen appears (see Figure 5).

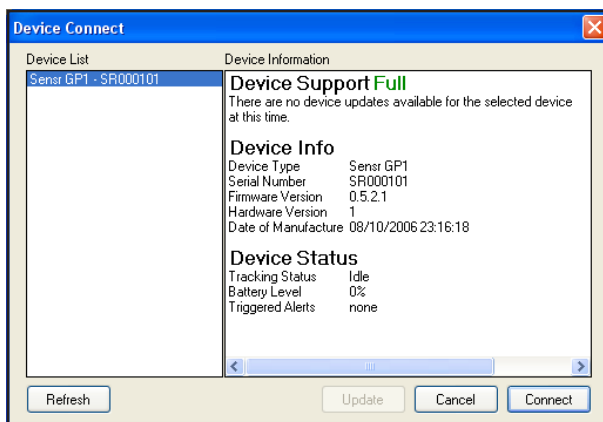

Figure 6 Device Connect

The Device Connect screen (Figure 6) identifies the Sensr instruments that are found during the scan and lists them in ‘Device List.’ Details about the selected instrument are highlighted in ‘Device Information.’ Once an instrument has been identified its compatibility is reviewed—if the instrument needs to be updated an update option is presented to the user.

**Caution: Updating an instrument will erase any stored mission data. Download the instrument before updating.**

From the Device Connect screen the user can:

- Refresh**                 Refresh the list of connected instruments
- Cancel**                   Cancel the operation
- Connect**                 Establishes communication with the selected instrument
- Update**                   Updates the instrument firmware (if required)

Selecting the “Connect” option establishes communication with the instrument and displays the Main Control Panel (see Figure 7).



Figure 7 Main Control Panel

## 6.5 Main Control Panel

The Main Control Panel (Figure 7) is the central interface for controlling Sensr instruments. From this panel the user can:

File> Open	Open a .snr file
File> Exit	Close Sensware
Device > Disconnect	Terminates communication with a Sensr instrument
Device > Initialize	Configures a Sensr instrument
Device > Download	Downloads data from a Sensr instrument
Device > Status	Reports instrument configuration and status
Device > Real Time Data Capture	Enables real-time data streaming
Device > Erase	Clears the instruments memory file
Device > Protect	Enables instrument password support
Help > Manual	Opens the GP1 User's Manual
Help > About	Displays Sensware program information

## 6.6 Device Initialization



Figure 8 Initialize Device Icon

Clicking the "Initialize Device" icon (Figure 8) will begin the configuration process to set up the GP1 for an upcoming mission. This action will bring up the GP1 Init General screen (see Figure 9). If a GP1 is attached that contains data the user will be prompted with an alert screen asking if the user wants to download or erase the data prior to configuring.



## 6.7 GP1 Init General

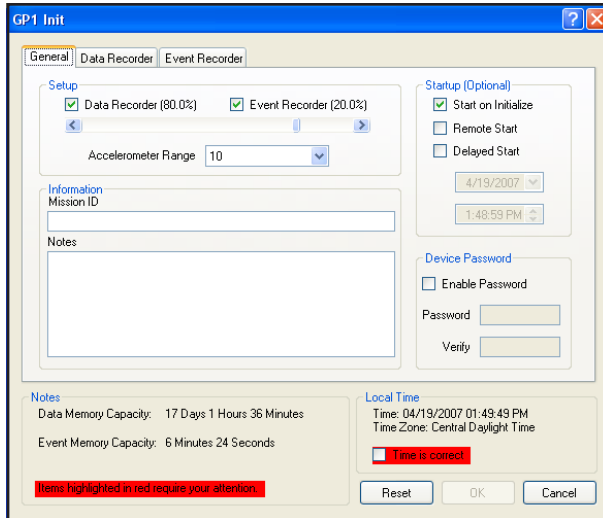

Figure 9 GP1 Init General Screen

The GP1 Init General screen (Figure 9) is organized into several sections:

- Setup** Select which recording mode(s) to enable, partition the memory allocation for each recorder and specify the G-range for the instrument.
- Information** Enter mission description information for documenting facts and circumstances relating to the mission. Entries in these fields will be recorded with the mission records and will print on reports.
- Notes** Displays configuration information relating to recording time as well as general alerts.
- Startup** Configures the start preferences for recording.
- Device Password** Enables and configures password functionality.  
**Note: If the password is forgotten the GP1 must be sent back to the factory for reset.**
- Local Time** Relays the local time as being reported from the host PC. Confirmation of the correct time is required to support accurate time-stamping of the data.  
**Note: All data records are time-stamped in UTC time.**





## 6.8 GP1 Init Data Recorder

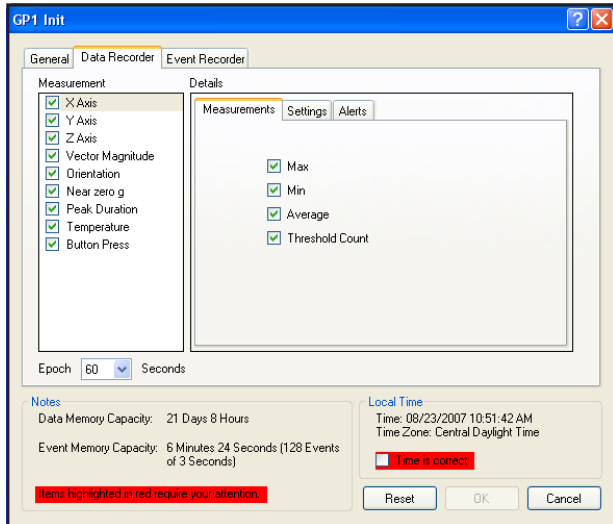

Figure 10 GP1 Init Data Recorder Screen

The GP1 Init Data Recorder screen (see Figure 10) is organized into several sections:

<b>Measurement</b>	Specifies the parameters to record and the reporting interval.
<b>Details</b>	Defines the attributes to record, recording options and alert settings.
<b>Notes</b>	Displays configuration information relating to recording time as well as general alerts.
<b>Local Time</b>	Relays the local time as being reported from the host PC. Confirmation of the correct time is required to support accurate time-stamping of the data. <b>Note: All data records are time-stamped in UTC time.</b>

For additional information about configuring the Data Recorder see Section 7.



## 6.9 GP1 Init Event Recorder

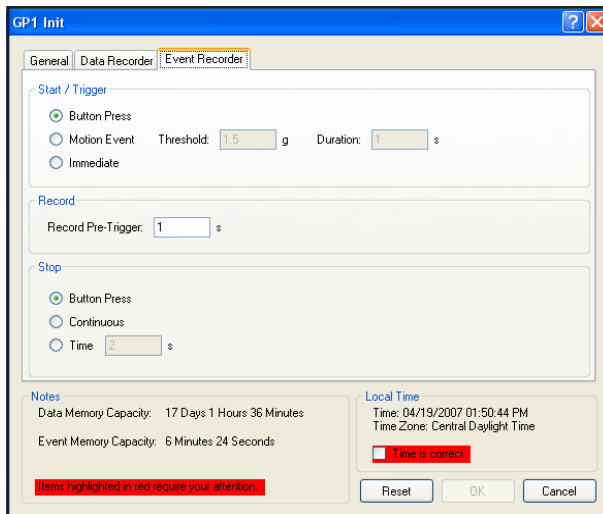

Figure 11 GP1 Init Event Recorder Screen

The GP1 Init Event Recorder screen (see Figure 11) is organized into several sections:

<b>Start/Trigger</b>	Specifies the Start/Trigger recording options.
<b>Record</b>	Select a pre-trigger recording duration.
<b>Stop</b>	Configures the Stop recording options.
<b>Notes</b>	Displays configuration information relating to recording time as well as general alerts.
<b>Local Time</b>	Relays the local time as being reported from the host PC. Confirmation of the correct time is required to support accurate time-stamping of the data. <b>Note: All data records are time-stamped in UTC time.</b>

For additional information about configuring the Event Recorder see section 8.



## 6.10 Downloading Data



Figure 12 Download Device Icon

Click the “Download Device” icon (Figure 12) on the Sensware Main Control Panel (See Figure 7) to download a GP1. Downloading a GP1 does not erase the data—the data will remain until you manually erase the unit (Device>Erase) or you initialize the unit for another mission.

## 6.11 Reviewing the Data

Once data has been downloaded from a GP1 it is displayed to the user in multiple formats: Summary Report, Data Report and Event Report.

### SUMMARY REPORT

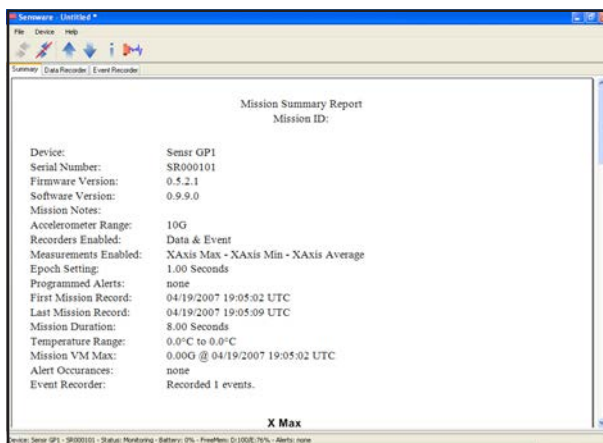

Figure 13 Summary Report Screen

The summary report (Figure 13) is used to provide a quick overview of the mission. The report is organized into several sections:

<b>Report Header</b>	Information header that describes the GP1’s configuration, alert settings and basic mission parameters.
<b>Mission Graphs</b>	Line graphs that display the individual measurement profiles for the entire mission.
<b>Orientation Table</b>	Orientation record that highlights the time, date and duration for each attitude change.
<b>Peak Duration/NZG</b>	First 10 Peak Duration records that have a near zero <i>g</i> association.
<b>Device Configuration</b>	Detailed information on the device configuration.



## DATA REPORT

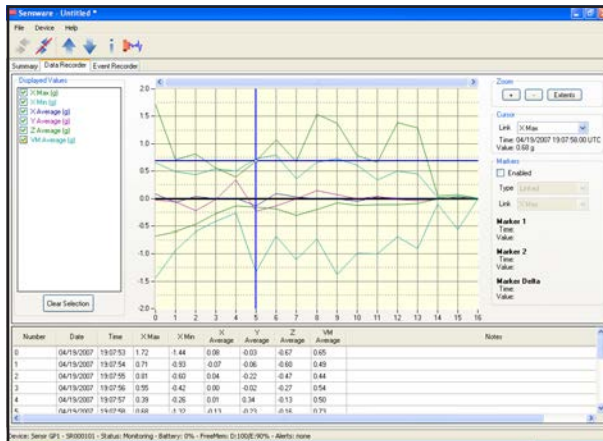

Figure 14 Data Report Screen

The data report (Figure 14) is the complete data record for the entire mission. You can access the data report by clicking the Data Recorder tab. The report is graph and table-based and is organized by the time interval that the user would have specified for the reporting epoch. The data report viewer is divided into several sections:

- Displayed Values** Specifies the data channels that are to be charted.
- Record** Table entries for each epoch outlining record ID, epoch date and time and the measurements that were recorded.
- Chart** Graphical plot of the recorded data. Depending upon the zoom function a scroll bar may appear above the chart for panning.
- Zoom** Zoom controls for the chart area.
- Cursor** Specifies which channel to bind the cursor movement. Details the current cursor's time and value information. The cursor appears as the blue crosshairs in the chart display. To move the cursor, position the mouse pointer over the cursor and hold down the left mouse-button while dragging the cursor. Moving the vertical portion of the crosshair will allow incrementing across the time axis and moving the horizontal portion of the crosshairs will allow incrementing the value axis.
- Markers** Enables markers to be displayed and positioned. Markers appear as red reference lines and can be used to mark reference points and measure features. There are two markers and they can be linked to a specific channel, time-based or value-based. Markers can be moved and manipulated in the same manner as the cursor.



## EVENT REPORT

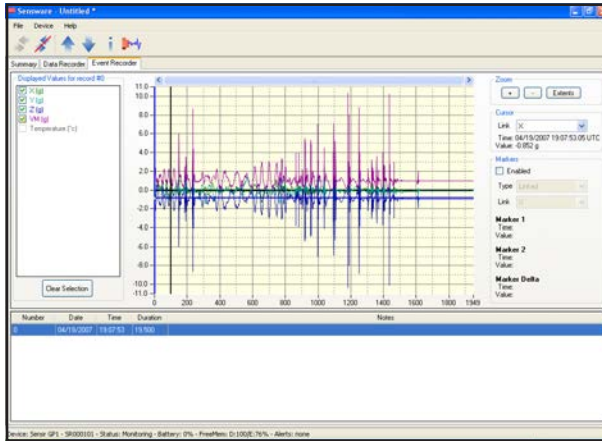

Figure 15 Event Report Viewer

The event report (Figure 15) is the collection of recordings that were captured by the Event Recorder. You can access the event report by clicking the Event Recorder tab. The report is graph and table-based and is organized by the sequential record entries. The event report viewer is divided into several sections:

<b>Displayed Values</b>	Specifies the data channels that are to be charted.
<b>Record</b>	Table entries for each of the recording sessions outlining record ID, date and time the file was recorded and the duration of the recording. Selecting a record displays the waveforms in the chart area.
<b>Chart</b>	Graphical plot of the recorded data. Depending upon the zoom function a scroll bar may appear above the chart for panning.
<b>Zoom</b>	Zoom controls for the chart area.
<b>Cursor</b>	Specifies which channel to bind the cursor movement. Details the current cursor's time and value information. The cursor appears as the blue crosshairs in the chart display. To move the cursor, position the mouse pointer over the cursor and hold down the left mouse-button while dragging the cursor. Moving the vertical portion of the crosshair will allow incrementing across the time axis and moving the horizontal portion of the crosshairs will allow incrementing the value axis.
<b>Markers</b>	Enables markers to be displayed and positioned. Markers appear as red reference lines and can be used to mark reference points and measure features. There are two markers and they can be linked to a specific channel, time-based or value-based. Markers can be moved and manipulated in the same manner as the cursor.



## 6.12 Device Information



Figure 16 Real Time Data Capture Icon

Selecting the “Real Time Data Capture” icon will display the Device Information screen (Figure 17).

### DEVICE INFORMATION



Figure 17 Device Information Screen

The Device Information screen (Figure 17) is organized into two sections:

<b>Information</b>	Details the hardware and firmware revision levels, the GP1’s status and current configuration information.
<b>Axis Check</b>	Displays the current output of the accelerometer and the internal temperature of the GP1. This feature can be used to verify the accelerometer’s response and general calibration.



## 6.13 Real Time Data Capture



Figure 18 Real Time Data Capture Icon

Selecting the “Real Time Data Capture” icon (Figure 18) will display the Real Time Capture screen (See Figure 19).

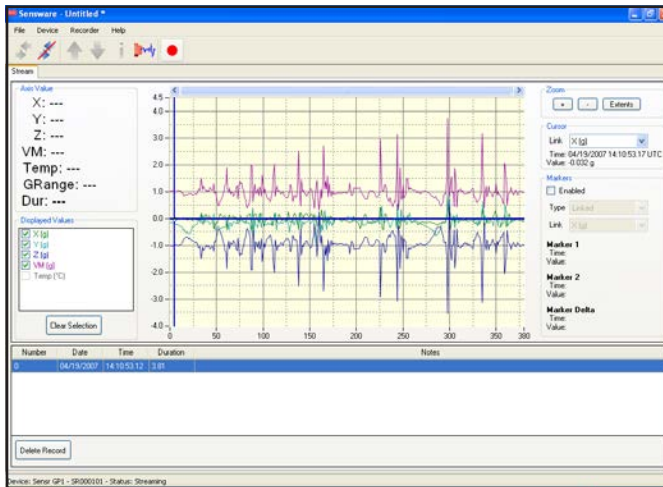

Figure 19 Real Time Data Capture Screen

From the Real Time Data Capture Screen (Figure 19) the user can:

File > Open	Open a .snr file
File > Close	Close the session and return to the Main Control Panel
File > Save	Save data to a .snr file
File > Save As	Save data using an alternative filename
File > Export Data	Export the data in a CSV format
File > Exit	Close Sensware
Device > Disconnect	Terminates communication with a Sensr instrument
Recorder > Record	Starts recording real-time data
Recorder > Allow Button	Enables the instrument’s Start button to control recording start and stop functions
Recorder > G Ranges	Selects the upper limit of the accelerometer
Help > Manual	Opens the GP1 User’s Manual
Help > About	Displays Sensware program information



The Real-Time Data Capture screen (see Figure 19) is organized into several sections:

<b>Axis Values</b>	Displays the sampled acceleration values for each axis and the calculated value for VM. The instrument's temperature, current <i>g</i> range setting and recording session length are also displayed.
<b>Displayed Values</b>	Specifies the data channels that are to be charted.
<b>Record</b>	Table entries for each of the recording sessions outlining record ID, date and time the file was recorded and the duration of the recording. Each time the user starts and stops the recorder a new record is created in the table. Selecting a record displays the waveforms in the chart area.
<b>Chart</b>	Graphical plot of the recorded data. Depending upon the zoom function a scroll bar may appear above the chart for panning.
<b>Zoom</b>	Zoom controls for the chart area.
<b>Cursor</b>	Specifies which channel to bind the cursor movement. Details the current cursor's time and value information. The cursor appears as the blue crosshairs in the chart display. To move the cursor, position your mouse pointer over the cursor and hold down the left mouse-button while you drag the cursor. Moving the vertical portion of the crosshair will allow you to increment across the time axis and moving the horizontal portion of the crosshairs will allow you to increment the value axis.
<b>Markers</b>	Enables markers to be displayed and positioned. Markers appear as red reference lines and can be used to mark reference points and measure features. There are two markers and they can be linked to a specific channel, time-based or value-based. Markers can be moved and manipulated in the same manner as the cursor.





## 7 CONFIGURING THE DATA RECORDER

The Data Recorder has a variety of options and settings that are used to tailor the recorder for specific applications.

### 7.1 XYZ Axis

#### 7.1.1 XYZ Axis Measurements

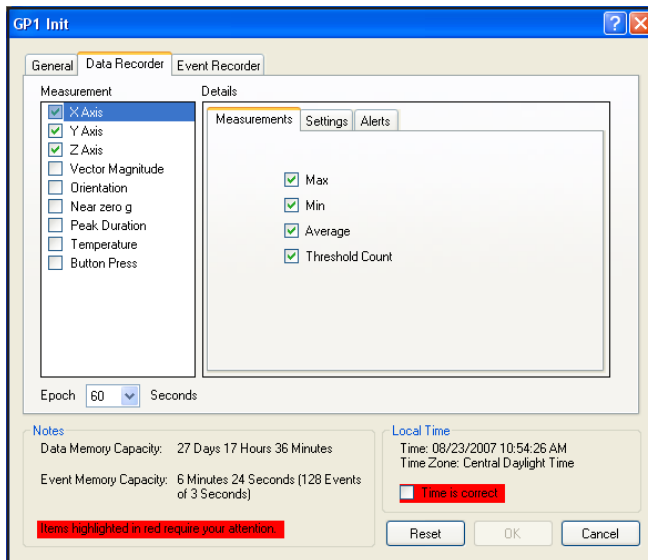

Figure 20 XYZ Measurement Screen

The XYZ Axis Measurement (Figure 20) recording options are:

<b>Max</b>	The highest sampled acceleration value per epoch (see Figure 21).
<b>Min</b>	The lowest sampled acceleration value per epoch (see Figure 21).
<b>Average</b>	The average acceleration value per epoch (see Figure 21).
<b>Threshold Count</b>	The number of times the acceleration value has exceeded a threshold.

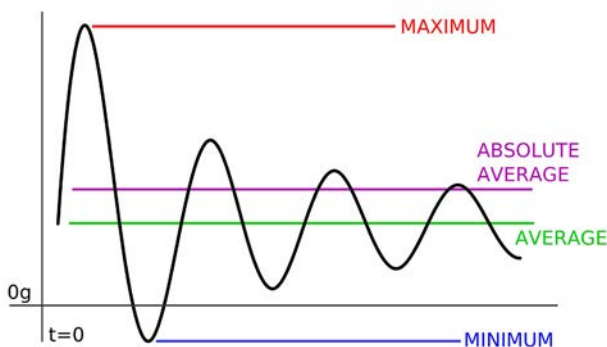

Figure 21 Axis Measurements



## 7.1.2 X Y Z Axis Settings

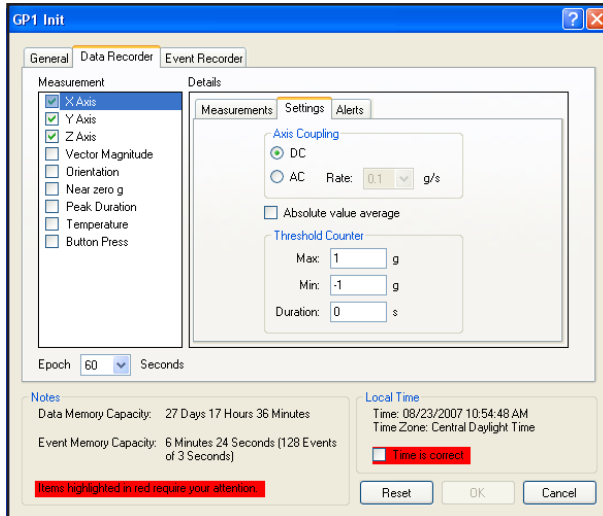

Figure 22 X Y Z Axis Settings Screen

The X Y Z Axis Settings (Figure 22) input response options are:

<b>DC Coupling</b>	Records the influence of gravity (1g) and other long-duration acceleration influences.
<b>AC Coupling</b>	Removes the influence of gravity and other long-duration acceleration influences. Requires a rate of acceleration removal to be defined.
<b>Rate</b>	Specifies the rate of removal for long-duration accelerations in g/second.
<b>Absolute Average</b>	Calculates the absolute average of acceleration inputs rather than the true average (see Figure 21). Note: This setting will influence the recorded values and the alert thresholds.
<b>Threshold Counter Max</b>	Specifies the upper limit for the threshold counter.
<b>Threshold Counter Min</b>	Specifies the lower limit for the threshold counter.
<b>Threshold Counter Duration</b>	Specifies the duration that the acceleration must exceed one of the specified limits (either Min or Max) in order to be counted.



### 7.1.3 X Y Z Axis Alerts

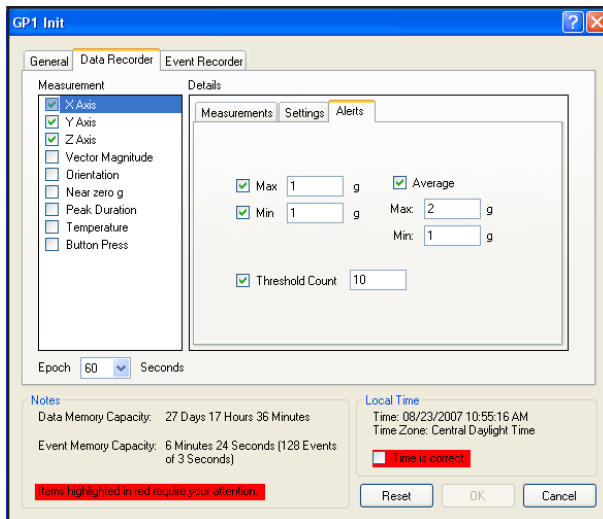

Figure 23 X Y Z Axis Alerts Screen

X Y Z Axis Alerts (Figure 23) threshold settings are:

<b>Max</b>	The highest sampled acceleration value (see Figure 21).
<b>Min</b>	The lowest sampled acceleration value (see Figure 21).
<b>Average Max</b>	The highest average acceleration per epoch (see Figure 21).
<b>Average Min</b>	The lowest average acceleration per epoch (see Figure 21).
<b>Threshold Count</b>	The minimum number of threshold counts required per epoch to trigger an alert.



## 7.2 Vector Magnitude

### 7.2.1 Vector Magnitude Measurements

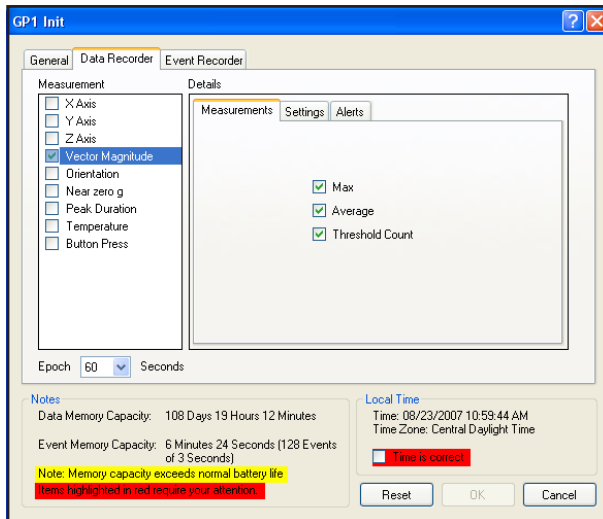

Figure 24 X Y Z Vector Magnitude Measurements Screen

The Vector Magnitude Measurements (Figure 24) recording options are:

<b>Max</b>	The highest sampled acceleration value per epoch (see Figure 21).
<b>Average</b>	The average acceleration value per epoch (see Figure 21).
<b>Threshold Count</b>	The number of times the vector magnitude value has exceeded a threshold.



## 7.2.2 Vector Magnitude Settings

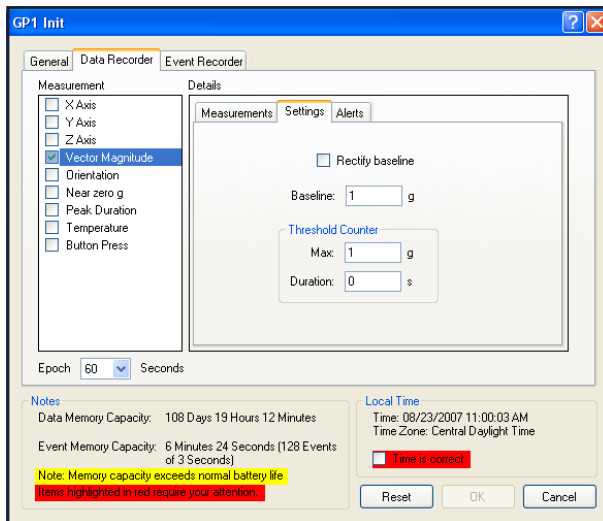

Figure 25 Vector Magnitude Settings Screen

The Vector Magnitude Settings (Figure 25) input response options are:

<b>Rectify baseline</b>	Rectify input values using the baseline as a reference. Inputs that are below the baseline will be rectified and recorded above the baseline. <b>Note: This setting will influence the recorded values and the alert thresholds.</b>
<b>Baseline</b>	Specifies an acceleration constant to remove, e.g. 1g for gravity.
<b>Threshold Counter Max</b>	Specifies the upper limit for the threshold counter.
<b>Threshold Counter Duration</b>	Specifies the duration that the vector magnitude must exceed the the limit in order to be counted.



### 7.2.3 Vector Magnitude Alerts

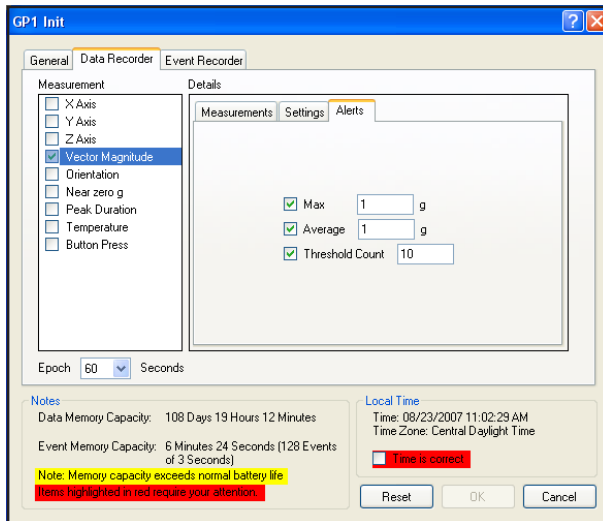

Figure 26 Vector Magnitude Alerts Screen

The Vector Magnitude Alerts (Figure 26) threshold settings are:

<b>Max</b>	The highest sampled acceleration value (see Figure 21).
<b>Average</b>	The average acceleration per epoch (see Figure 21).
<b>Threshold Count</b>	The minimum number of threshold counts require per epoch to trigger an alert.



## 7.3 Orientation

### 7.3.1 Orientation Settings

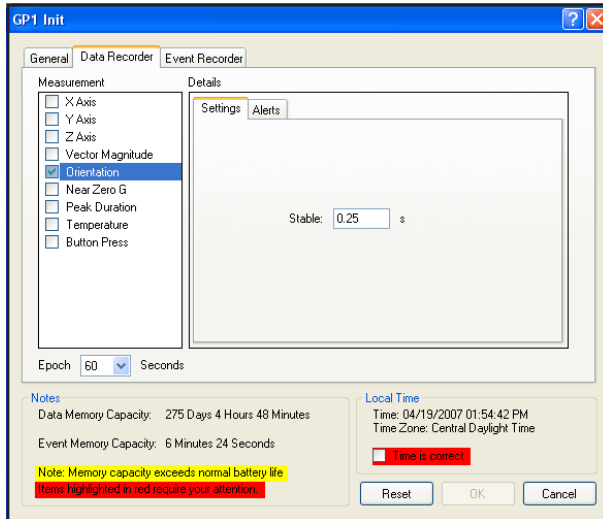

Figure 27 Orientation Settings Screen

The Orientation Settings (Figure 27) variable is :

#### Stable

The amount of time the instrument has to remain in a given orientation before it records the orientation. Setting this variable to low may report vibration induced attitude changes as orientation changes.



## 7.3.2 Orientation Alerts

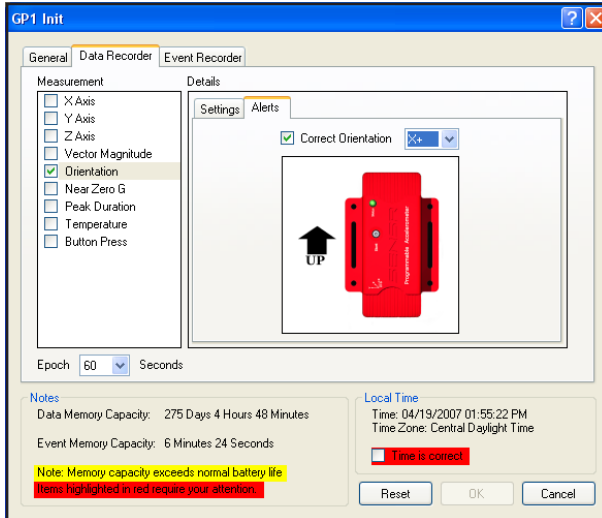

Figure 28 Orientation Alerts Screen

The Orientation Alerts (Figure 28) variable is:

Correct Orientation

Specify the preferred orientation of how the GP1 will be mounted.

**Note: Orientation monitoring does not require setting alerts—orientation logging is always enabled if orientation monitoring is enabled.**





## 7.4 Near Zero G

### 7.4.1 Near Zero G Measurements

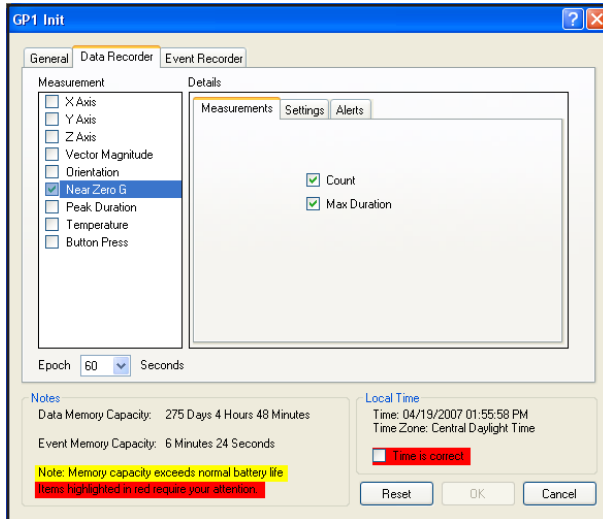

Figure 29 Near Zero G Measurements Screen

The Near Zero G Measurements (Figure 29) options are:

#### Count

The Near Zero G Count is how many qualifying near zero *g* events occurred within an epoch. A qualifying event is one that meets or exceeds a specified threshold and triggering duration (see Figure 30).

#### Max Duration

The Near Zero G Max Duration is the longest period within an epoch that the GP1 was in a near zero *g* state (see Figure 31).

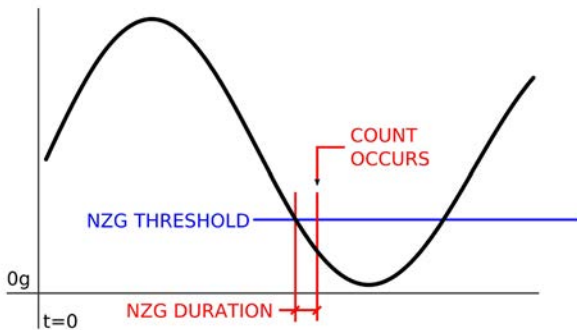

Figure 30 Near Zero G Count

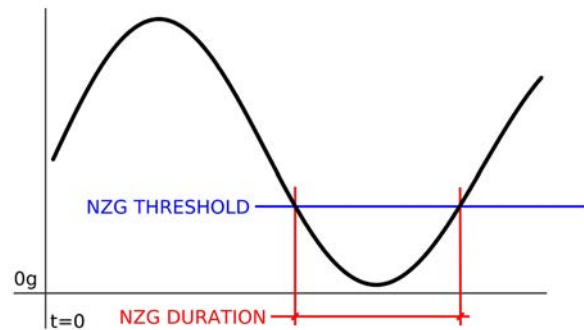

Figure 31 Near Zero G Max Duration



## 7.4.2 Near Zero G Settings

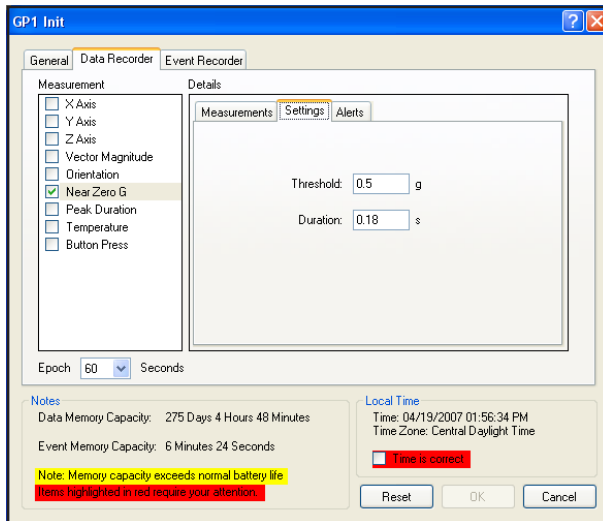

Figure 32 Near Zero G Settings Screen

The Near Zero G Settings (Figure 32) variables are:

### Threshold

The  $g$  value that you want to use to signify a near zero  $g$  event (see Figure 30). Examples of near zero  $g$  events include tosses, throws, drops and other free-fall states.

### Duration

The triggering time variable that qualifies a near zero  $g$  event (see Figure 30).

**Note: This variable is not required if Max Duration is the only measurement being recorded.**



## 7.4.3 Near Zero G Alerts

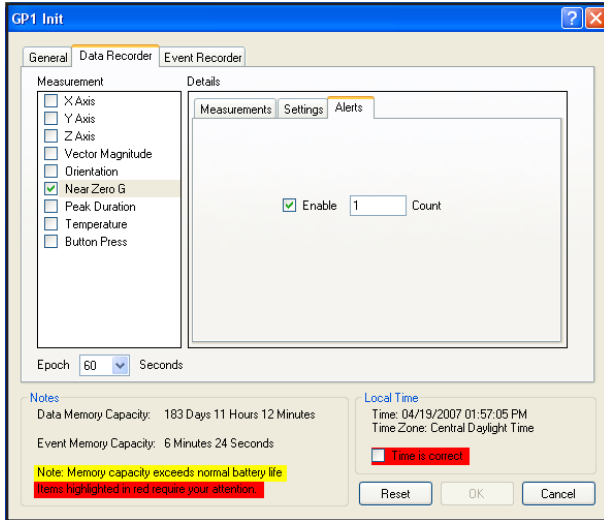

Figure 33 Near Zero G Alerts Screen

The Near Zero G Alerts (Figure 33) variable is:

**Count**

The number of near zero *g* events per epoch that trigger an alert.



## 7.5 Peak Duration

### 7.5.1 Peak Duration Settings

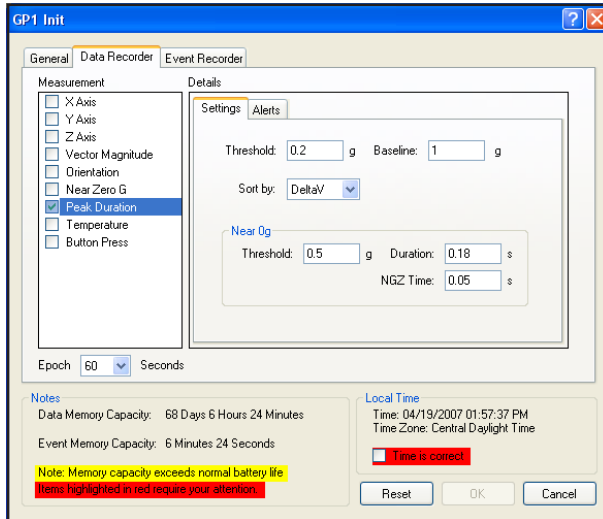

Figure 34 Peak Durations Settings Screen

The Peak Duration Settings (Figure 34) variables are:

<b>Threshold</b>	The trip threshold used to qualify a Peak Duration event (see figure 35).
<b>Baseline</b>	Specifies an acceleration constant to remove, e.g. 1g for gravity (see figure 35).
<b>Sort by</b>	Select the sort criteria to identify the most significant event per epoch (see Figure 35). The options are: <ul style="list-style-type: none"> <li><b>DeltaV</b> Rank events by velocity change</li> <li><b>Peak</b> Rank events by peak values</li> <li><b>Duration</b> Rank events by total length</li> </ul>
<b>NZG Threshold</b>	The <i>g</i> value that you want to use to signify a near zero <i>g</i> event (see Figure 35). Examples of near zero <i>g</i> events include tosses, throws, drops and other free-fall states.
<b>Duration</b>	The triggering time variable that qualifies a near zero <i>g</i> event (see Figure 35).
<b>NZG Time</b>	The association time that links a Peak Duration event with a near zero <i>g</i> event (see Figure 35).

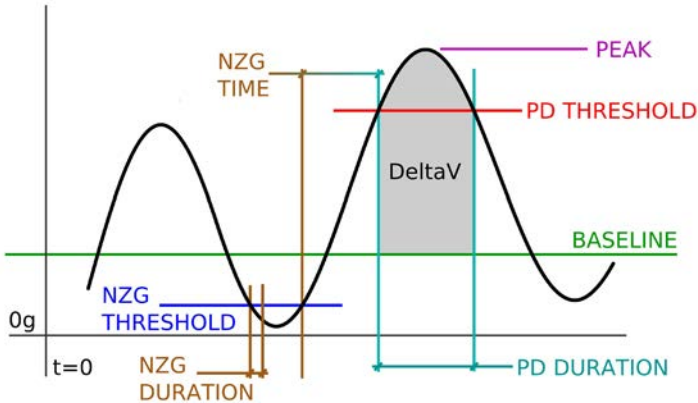

Figure 35 Peak Duration Event



## 7.5.2 Peak Duration Alerts

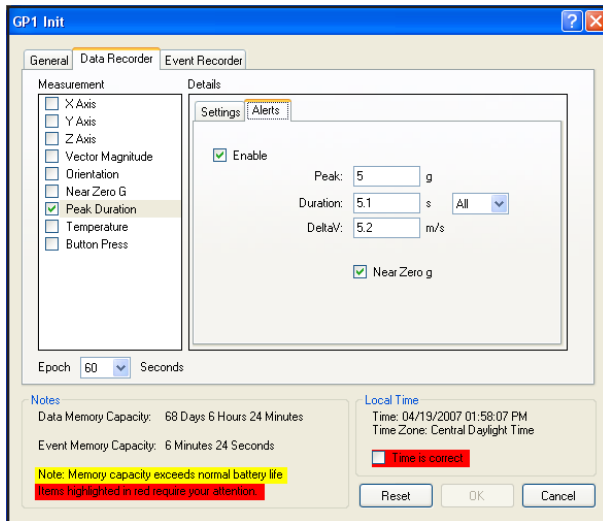

Figure 36 Peak Duration Alerts Screen

Peak Duration Alerts (Figure 36) variables are:

<b>Peak</b>	Highest $g$ value sampled that is over the Peak Duration threshold (see Figure 35).
<b>Duration</b>	The length of a Peak Duration event (see Figure 35).
<b>DeltaV</b>	The Peak Duration event's velocity change (see Figure 35).
<b>All/Any</b>	Alert criteria conditions; all conditions must be met or any one condition is met.
<b>Near Zero G</b>	Specifies that an alert event must have a near zero $g$ event associated with it.



## 7.6 Temperature

### 7.6.1 Temperature Alerts

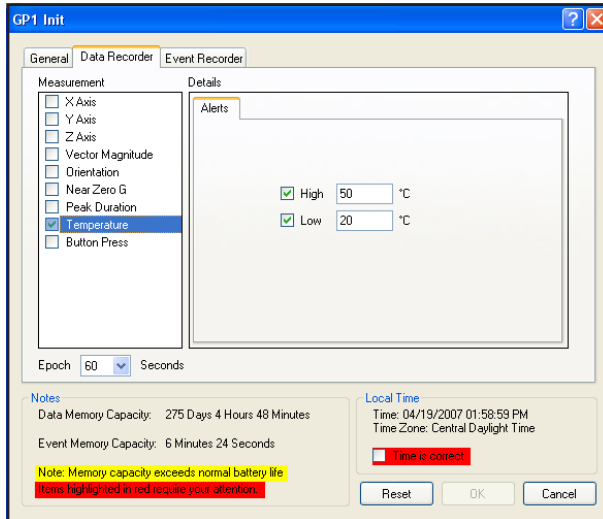

Figure 37 Temperature Alerts Screen

The Temperature Alerts (Figure 37) variables are:

#### High

High temperature alert threshold. Temperature is sampled every 10 seconds. The maximum GP1 operating temperature is +80°C.

**Note: Consult the battery's data sheet to determine the maximum operating temperature of the instrument with batteries.**

#### Low

Low temperature alert threshold. The minimum GP1 operating temperature is -20°C. Note: Consult the battery's data sheet to determine the minimum operating temperature of the instrument with batteries.



## 7.7 Button Press

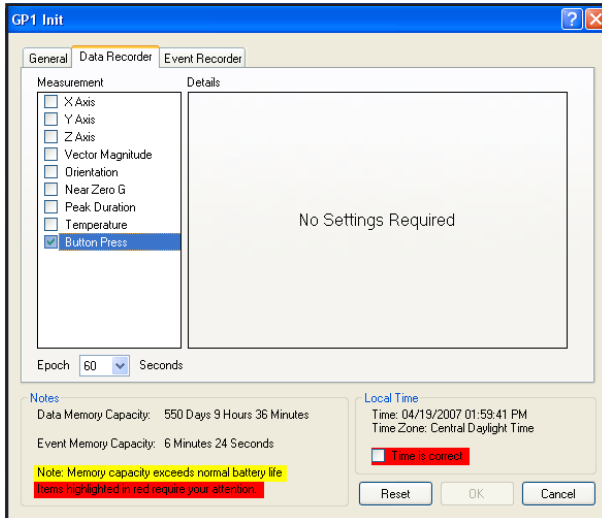

Figure 38 Button Press Screen

There are no additional variables for specifying a button press—the instrument will record the time and date of each button press. A button press alert requires the button to be pressed and held for  $\frac{1}{2}$  second. The status LED will confirm a recorded button press alert by flashing a  $\frac{1}{2}$ -second green indicator.





## 8 CONFIGURING THE EVENT RECORDER

The Event Recorder has a variety of options and settings that are used to tailor the recorder for specific applications.

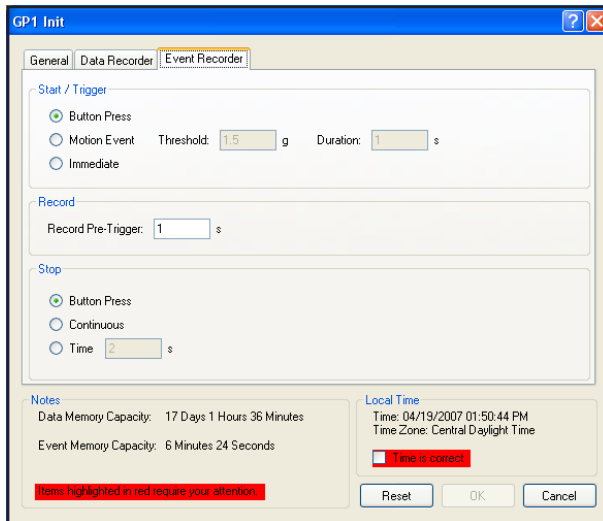

Figure 39 Event Recorder Screen

The Event Recorder (Figure 39) variable settings are:

<b>Start Button Press</b>	Recording begins as soon as the “Start” button is pressed and held for ½ second—the status LED will confirm a button press by flashing a ½-second green indicator. The GP1 will rapid-flash the green indicator when it is recording and rapid-flash the yellow indicator when it is not recording.
<b>Start Motion Threshold</b>	Recording begins when a specified vector magnitude threshold is met or exceeded (see Figure 40).
<b>Start Motion Duration</b>	The triggering time variable that qualifies a Start Motion Threshold (see Figure 40).
<b>Start Immediate</b>	Begins recording as soon as the GP1 is initialized.
<b>Record Pre-Trigger</b>	Specifies the amount of pre-trigger recording time the instrument records per event (see Figure 40).
<b>Stop Button Press</b>	GP1 stops recording data when the button is pressed and held for ½ second—the status LED will confirm a button press by flashing a ½-second green indicator.
<b>Stop Continuous</b>	Will record data until the memory is full.
<b>Stop Time</b>	Specifies the amount of post-trigger recording time the instrument records per event (see Figure 40).

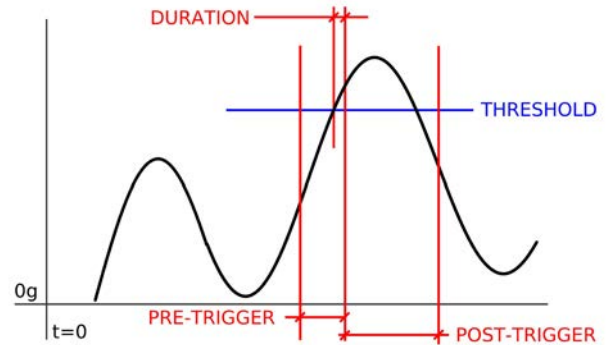

Figure 40 Event Recorder



## 9 SAVING DATA

---

The native Sensware data format is a .snr file; in order to view this file the user will need a copy of Sensware installed on their computer. The Sensware license agreement allows the user to install multiple copies of Sensware. Software is available for download from the Sensr website [www.Sensr.com](http://www.Sensr.com).

## 10 EXPORTING DATA

---

Data records can be exported as a .CSV file for additional analysis. To export the data file select File>Export to CSV and choose a destination and file name.

## 11 MISCELLANEOUS

---

### 11.1 GP1 Maintenance

- |                    |  |
|--------------------|--|
| <b>Cleaning</b>    | The GP1 can be cleaned by dampening a cloth with Windex™ and wiping down the exterior surfaces. Do not spray cleaning fluid directly on the GP1.   |
| <b>Calibration</b> | The GP1 uses a DC response accelerometer and is calibrated using the earth's gravity. The unit is factory-calibrated using precision surface plates and temperature chambers; users who want to check the calibration of their unit can connect a unit to the PC and click the "info" icon within Sensware and see the output of the accelerometer. If it is suspected the unit requires calibration the user can contact the factory to arrange a review. |
| <b>Storage</b>     | If the GP1 is to be stored for more than 20 days it is recommended that the batteries are removed from the unit and stored separately. Store the unit in a dry, indoor environment.  |

### 11.2 Technical Support

For questions about the GP1 or an application, e-mail support at [support@Sensr.com](mailto:support@Sensr.com) or call 563.245.3750. Standard hours of operation are 8 am - 5 pm CST, M—F.

### 11.3 Product Warranty

Reference LLC. ("Reference") warrants to the original Customer ("Customer") that SENSr brand instruments ("Product") are free from defects in material and workmanship under normal use and service for a period of 1 year commencing upon the date of purchase.

This Limited Warranty is conditioned upon proper use of Product by Customer. This Limited Warranty does not cover: (a) defects or damage resulting from accident, misuse, abuse, neglect, unusual physical, electrical or electromechanical stress, or modification of any part of Product, including cables, or cosmetic damage; (b) equipment that has the serial number removed or made illegible; (c) any surfaces or other externally exposed parts that are scratched or damaged due to normal use; (d) malfunctions resulting from the use of Product in conjunction with accessories, products, or ancillary/peripheral equipment not furnished or approved by Reference; (e) defects or damage from improper testing, operation, maintenance, installation, or adjustment; (f) installation, maintenance, and service of Product, or (g) Product used or purchased outside the United States or Canada. During the warranty period, Reference will repair or replace, at Reference's sole option, without charge to Customer, any defective component part of Product.



To obtain service under this Limited Warranty, Customer must contact SENSr Customer care at 1.563.245.3750. Upon receipt, Reference will promptly repair or replace the defective Product. Reference may, at Reference's sole option, use rebuilt, reconditioned, or new parts or components when repairing any Product or replace Product with a rebuilt, reconditioned or new Product. Repaired or replaced product will be warranted for a period equal to the remainder of the original Limited Warranty on the original Product or for 90 days, whichever is longer. All replaced parts, components, boards and equipment shall become the property of Reference. If Reference determines that any Product is not covered by this Limited Warranty, Customer must pay all parts, shipping, and labor charges for the repair or return of such Product.

EXCEPT AS SET FORTH IN THE EXPRESS WARRANTY CONTAINED HEREIN, CUSTOMER TAKES THE PRODUCT "AS IS," AND REFERENCE MAKES NO WARRANTY OR REPRESENTATION AND THERE ARE NO CONDITIONS, EXPRESS OR IMPLIED, STATUTORY OR OTHERWISE, OF ANY KIND WHATSOEVER WITH RESPECT TO THE PRODUCT, INCLUDING BUT NOT LIMITED TO: THE MERCHANTABILITY OF THE PRODUCT OR ITS FITNESS FOR ANY PARTICULAR PURPOSE OR USE; OR COMPLIANCE OF THE PRODUCT WITH THE REQUIREMENTS OF ANY LAW, RULE, SPECIFICATION OR CONTRACT PERTAINING THERETO. NOTHING CONTAINED IN THE INSTRUCTION MANUAL SHALL BE CONSTRUED TO CREATE AN EXPRESS WARRANTY OF ANY KIND WHATSOEVER WITH RESPECT TO THE PRODUCT. ALL IMPLIED WARRANTIES AND CONDITIONS THAT MAY ARISE BY OPERATION OF LAW, INCLUDING IF APPLICABLE THE IMPLIED WARRANTIES OF MERCHANTABILITY AND FITNESS FOR A PARTICULAR PURPOSE, ARE HEREBY LIMITED TO THE SAME DURATION OF TIME AS THE EXPRESS WRITTEN WARRANTY STATED HEREIN. SOME STATES/PROVINCES DO NOT ALLOW LIMITATIONS ON HOW LONG AN IMPLIED WARRANTY LASTS, SO THE ABOVE LIMITATION MAY NOT APPLY TO YOU. IN ADDITION, REFERENCE SHALL NOT BE LIABLE FOR ANY DAMAGES OF ANY KIND RESULTING FROM THE PURCHASE, USE, OR MISUSE OF, OR INABILITY TO USE THE PRODUCT OR ARISING DIRECTLY OR INDIRECTLY FROM THE USE OR LOSS OF USE OF THE PRODUCT OR FROM THE BREACH OF THE EXPRESS WARRANTY, INCLUDING INCIDENTAL, SPECIAL, CONSEQUENTIAL OR SIMILAR DAMAGES, OR LOSS OF ANTICIPATED PROFITS OR BENEFITS, OR FOR DAMAGES ARISING FROM ANY TORT (INCLUDING NEGLIGENCE OR GROSS NEGLIGENCE) OR FAULT COMMITTED BY REFERENCE, ITS AGENTS OR EMPLOYEES, OR FOR ANY BREACH OF CONTRACT OR FOR ANY CLAIM BROUGHT AGAINST CUSTOMER BY ANY OTHER PARTY. SOME STATES/PROVINCES DO NOT ALLOW THE EXCLUSION OR LIMITATION OF INCIDENTAL OR CONSEQUENTIAL DAMAGES, SO THE ABOVE LIMITATION OR EXCLUSION MAY NOT APPLY TO YOU. THIS WARRANTY GIVES YOU SPECIFIC LEGAL RIGHTS, AND YOU MAY ALSO HAVE OTHER RIGHTS, WHICH VARY FROM STATE TO STATE/ PROVINCE TO PROVINCE. THIS LIMITED WARRANTY SHALL NOT EXTEND TO ANYONE OTHER THAN THE ORIGINAL CUSTOMER OF THIS PRODUCT AND STATES CUSTOMER'S EXCLUSIVE REMEDY. IF ANY PORTION OF THIS LIMITED WARRANTY IS HELD ILLEGAL OR UNENFORCEABLE BY REASON OF ANY LAW, SUCH PARTIAL ILLEGALITY OR UNENFORCEABILITY SHALL NOT AFFECT THE ENFORCEABILITY FOR THE REMAINDER OF THIS LIMITED WARRANTY WHICH CUSTOMER ACKNOWLEDGES IS AND WILL ALWAYS BE CONSTRUED TO BE LIMITED BY ITS TERMS OR AS LIMITED AS THE LAW PERMITS.